



7th June, 2017

1. The Secretary

Bombay Stock Exchange Limited
Phiroze Jeejeebhoy Towers, Dalal Street
MUMBAI 400 001.
Fax No. 022 - 2272 3121 / 3719 / 2037 / 2039 / 2041 / 2061
Scrip Code: 505242

2. The Secretary

National Stock Exchange of India Limited
"Exchange Plaza", Bandra-Kurla Complex,
Bandra East, MUMBAI 400 051.
Fax No.022 - 26598237 / 38
Scrip Code: DYNAMATECH

Sub: Institutional Investor Meet and Presentation on Financial Results

Ref: Scrip code: NSE: DYNAMATECH; BSE: 505242

Dear Sir,

In further to our letter dated 6th June 2017, we inform you that the executives of Dynamatic Technologies Limited attended investors' meeting at Mumbai on 6th June 2017. A copy of presentation made by our executives at the said investors meeting has been enclosed.

In necessary compliance with Regulation 46 of the SEBI (LODR) Regulations, 2015, the Company has also uploaded this information on its website.

We kindly request you to take on record the contents of this letter.

Thank you.

Yours faithfully,
for **DYNAMATIC TECHNOLOGIES LIMITED**

Naveen Chandra P
Head Legal, Compliance & Company Secretary
Enclosure: as above

DYNAMATIC TECHNOLOGIES LIMITED

Q4 & Full Year FY2017 EARNINGS
PRESENTATION

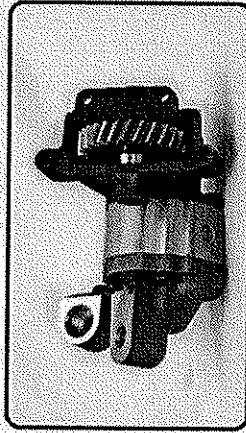

HYDRAULICS

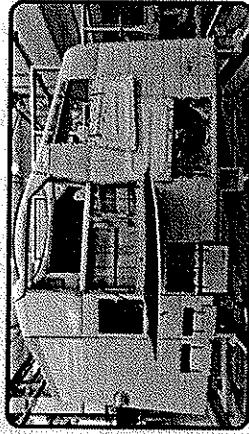

AEROSPACE & DEFENCE



AUTOMOTIVE



DYNAMATIC TECHNOLOGIES LIMITED



BORN TO FLY

DYNAMATIC TECHNOLOGIES LIMITED



12M FY2017 PERFORMANCE HIGHLIGHTS

Y-o-Y Highlights

- Net Revenue of Rs.15,078 mn; up 0.9% from Rs.14,938 mn last year
 - Aerospace & Defence segment revenue of Rs.3,457 mn; up 28.1% from Rs. 2,698 mn last year
- EBITDA of Rs.1,653 mn; up 17.2% from Rs.1,411 mn last year
 - EBITDA margin of 11.0%; up 152 bps
- PAT of Rs.146 mn; up by 19.0% from Rs.123 mn last year
- Adjusted PAT of Rs. 213 million; up by 73.4% from Rs. 123 mn last year
- FY2017 PAT was impacted due to an one time exceptional item of Rs. 101 mn. Excluding the exceptional item, FY2017 PAT growth would have been 73.4% y-o-y

12M FY2017 Revenue Breakup

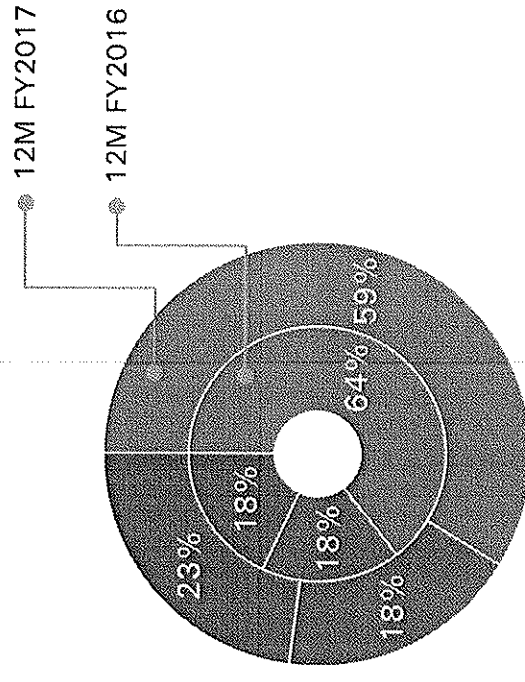

■ Automotive
■ Aerospace & Defence
■ Hydraulics



DYNAMATIC TECHNOLOGIES LIMITED

FINANCIAL PERFORMANCE SUMMARY

Consolidated Performance Highlights

Rs. Million	Q4		Y-o-Y Growth (%)	Q3	q-o-q Growth (%)	12 Month		Y-o-Y Growth (%)
	FY17	FY16				FY17	FY16	
Revenue	3,783	3,878	(2.5)%	3,520	7.5%	15,078	14,938	0.9%
EBITDA	388	528	(26.4)%	335	15.7%	1,653	1,411	17.2%
Margin (%)	10.3%	13.6%		9.5%		11.0%	9.4%	
Profit After Tax (PAT)	(74)	192	nm	12	nm	146	123	19.0%
Margin (%)	nm	5.0%		0.3%		1.0%	0.8%	
Basic EPS (Rs.)	(11.76)	30.30	nm	1.86	nm	23.02	19.36	19.1%
Adjusted PAT (Rs.)	(8)	192	nm	12	nm	213	123	73.4%
Margin (%)	nm	5.0%		0.3%		1.4%	0.8%	

Note: PAT was negatively impacted due to an one time exceptional item of Rs. 101 mn, on account of foreclosure of high cost borrowing. Adjusted PAT excludes exceptional items amounting to Rs. 78.8 mn from Indian operations net of standalone FY2017 effective tax rate and Rs. 22.4 mn from foreign operations without any applicable tax rate

- FY2017 PAT on an adjusted basis, excluding the one time exceptional item of Rs. 101 mn, increased by 73.4%
- FY2017 EBITDA margin expanded by 152 bps y-o-y due to strong operating margin profile of Aerospace & Defence and Hydraulics segments
- FY2017 Revenue increased marginally by 0.9% y-o-y. Revenues from Aerospace & Defence and Hydraulics segments increased substantially by 28.1% and 6.0%, respectively on a y-o-y basis
- Continued strong performance of the Aerospace & Defence segment (+28.1% y-o-y), was driven by ramp up in the client deliveries for new projects. Deliveries of all three new projects namely Airbus, Boeing and Bell started. Hydraulics segment growth was largely stable

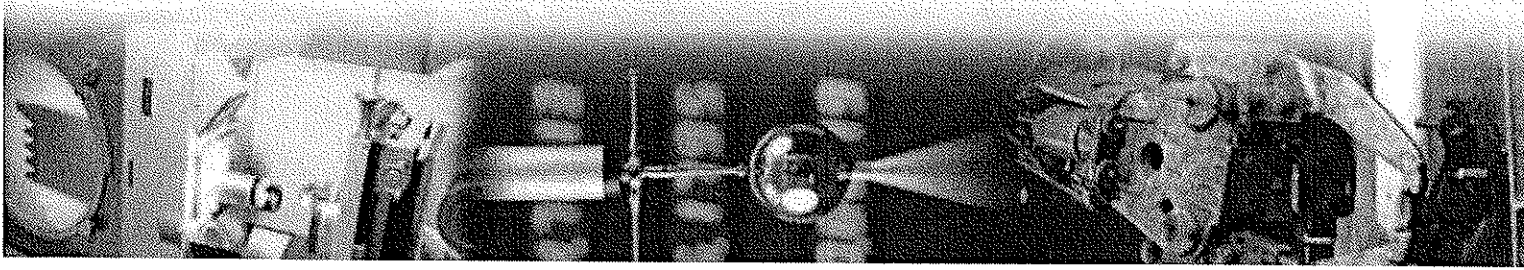

DYNAMIC TECHNOLOGIES LIMITED

INAUGURATION OF NEW SWINDON FACTORY

UK - first for DMG MORI milling centre at Dynamic-Oldland Aerospace™

Dynamic-Oldland Aerospace™ is installing a **DMG MORI DMC 340 U RS4 Giga Milling Centre** in a new purpose built unit at its Swindon facility, the first machine of this type in the private sector in Britain.

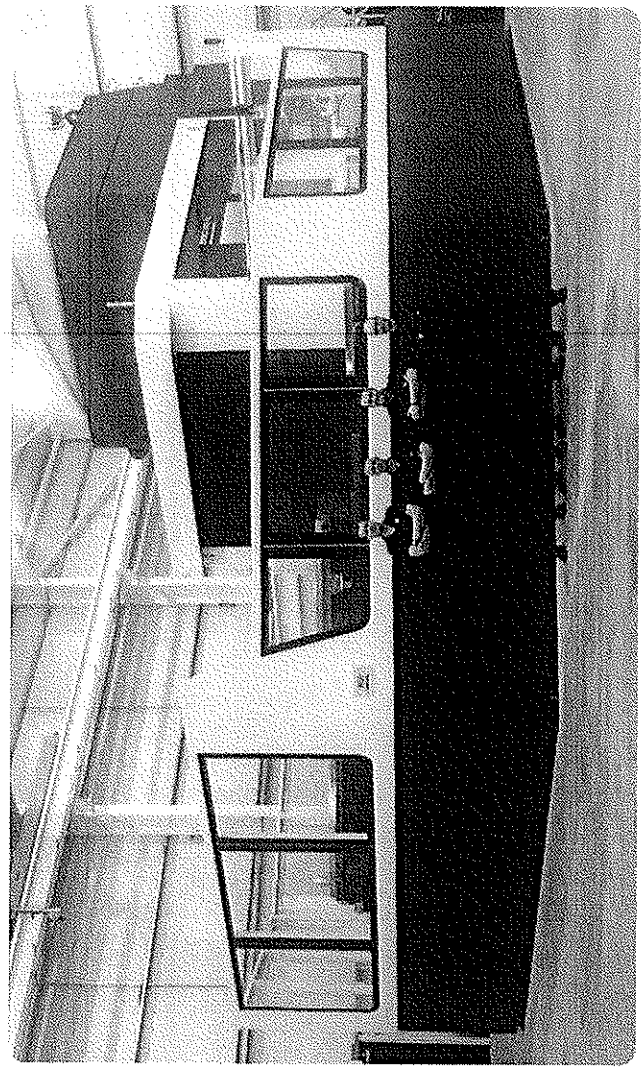
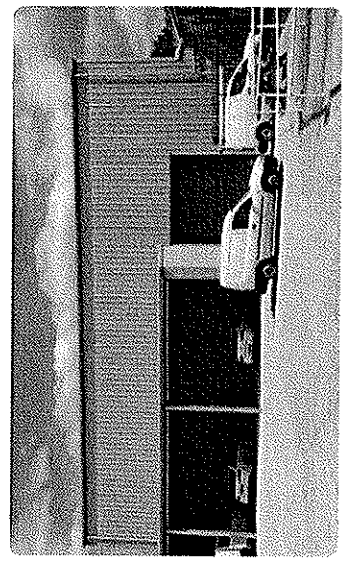
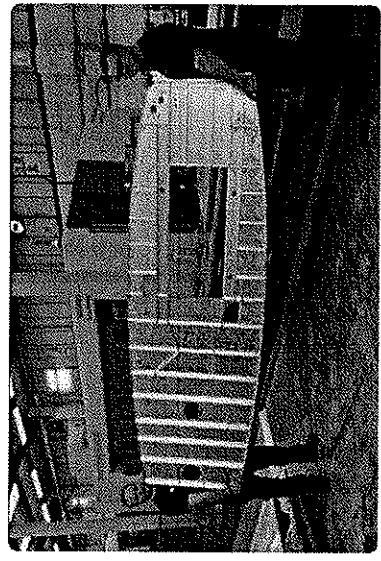

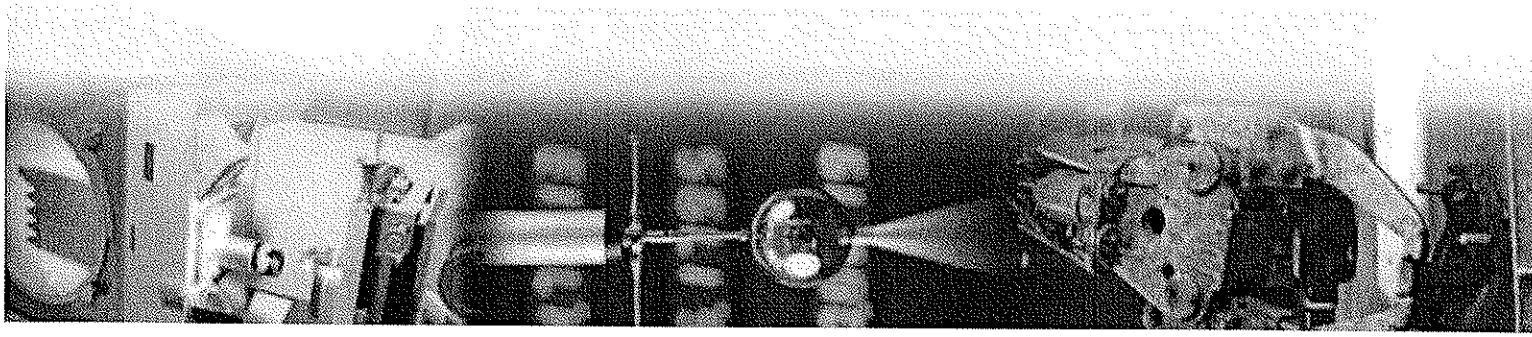

DYNAMATIC TECHNOLOGIES LIMITED

INAUGURATION OF DYNAMATIC AEROTROPOLIS

'HANGAR 1' FOR BELL PROGRAM

Inaugurated by **Mr. R V Deshpande** – Minister for Large & Medium Industries & Infrastructure Development, **Honourable Sir Dominic Anthony Gerard Asquith** - British High Commissioner, **Ms. MaryKay Loss Carlson** - Charge d'Affaires at the U.S. Embassy & **Mr. Udayant Malhoutra** – CEO & Managing Director, Dynamatic Technologies Limited.

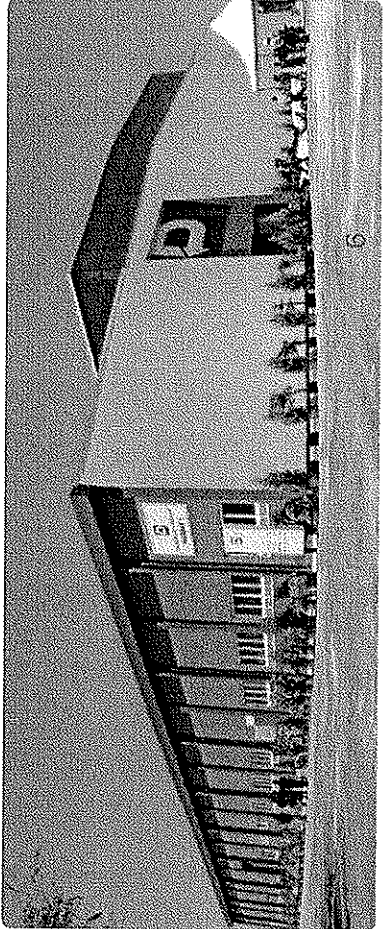
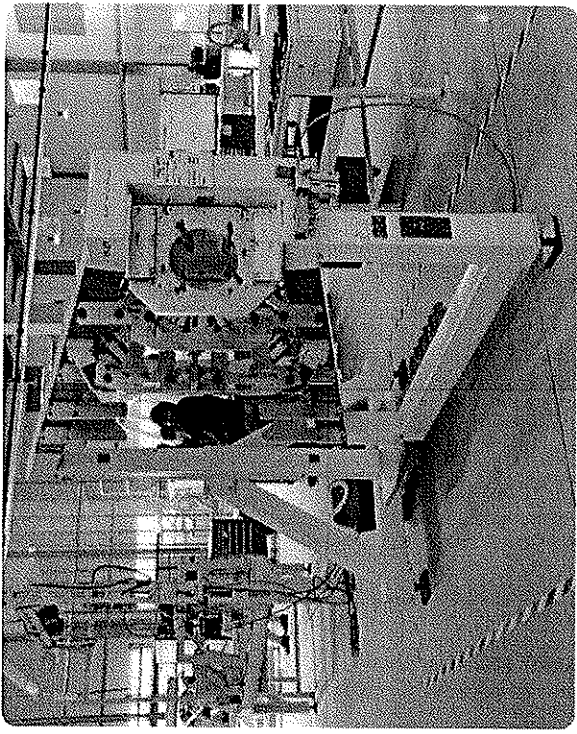
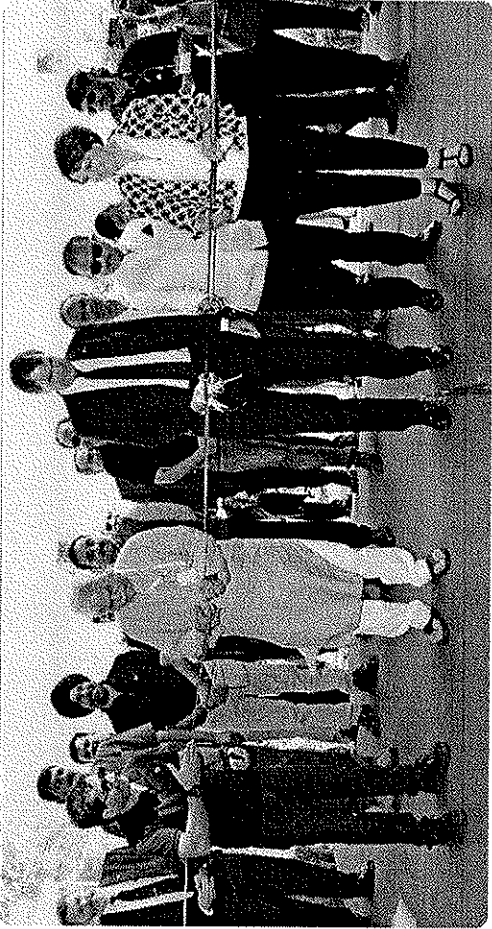

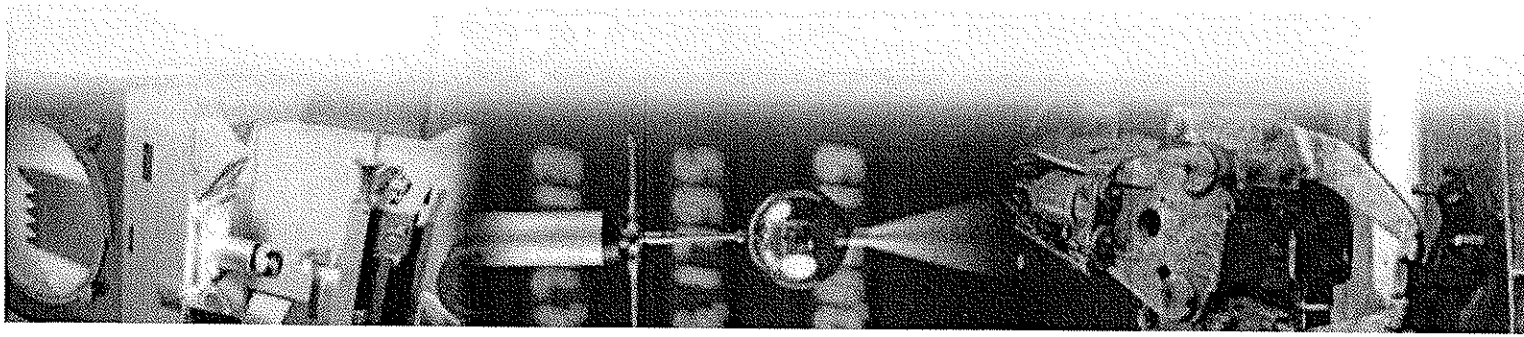

DYNAMATIC TECHNOLOGIES LIMITED

INAUGURATION OF NEW FACILITY FOR AIRBUS

AT DYNAMATIC AEROTROPOLIS

Inaugurated by **Mr. Pierre de Bausset**, President, Airbus Group India, **Mr. Klaus Richter**, Chief Procurement Officer, Airbus Group SE, **Mr. Tom Williams**, Chief Operating Officer, Airbus, **Mr. Srinivasan Dwarakanath**, Managing Director, Airbus India and **Mr. Udayant Malhoutra**, CEO & Managing Director, Dynamatic Technologies Limited

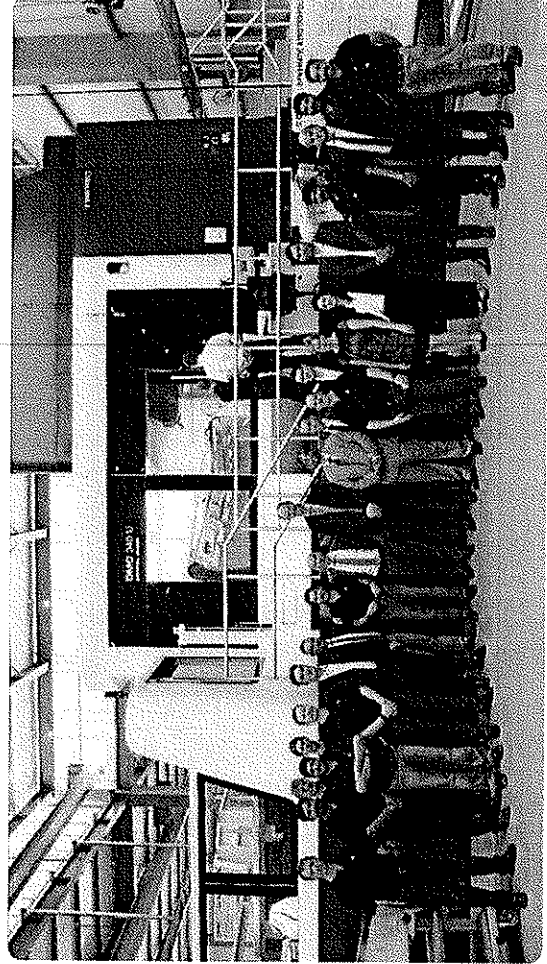

The company has added state-of-the-art manufacturing technologies including micron-tolerance 5 Axis Giga Milling DMC 340U, with real time geometric positioning software, for the first time in India

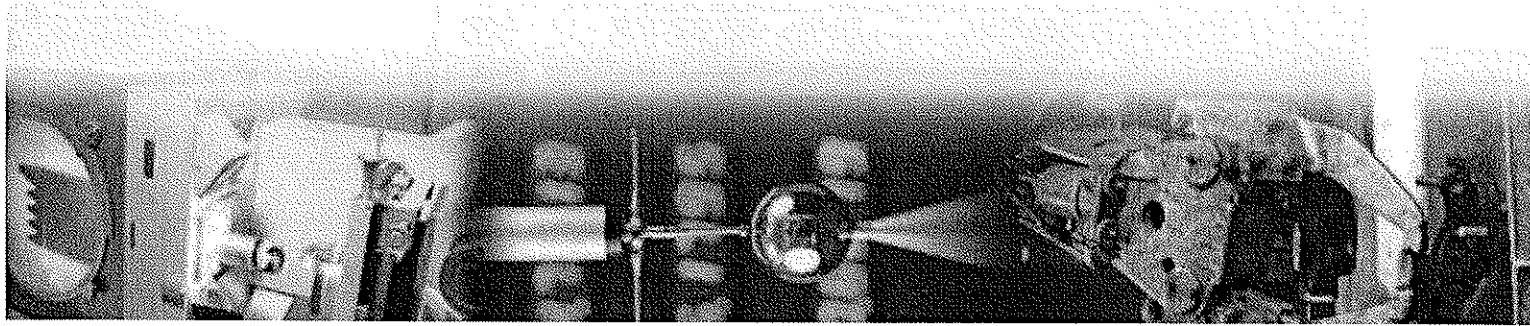

DYNAMATIC TECHNOLOGIES LIMITED
INAUGURATION OF FIRST MACHINING FACILITY

at EISENWERK ERLA GmbH, GERMANY

The First Machining Facility was inaugurated by the Board of Directors, Dynamatic Technologies Limited

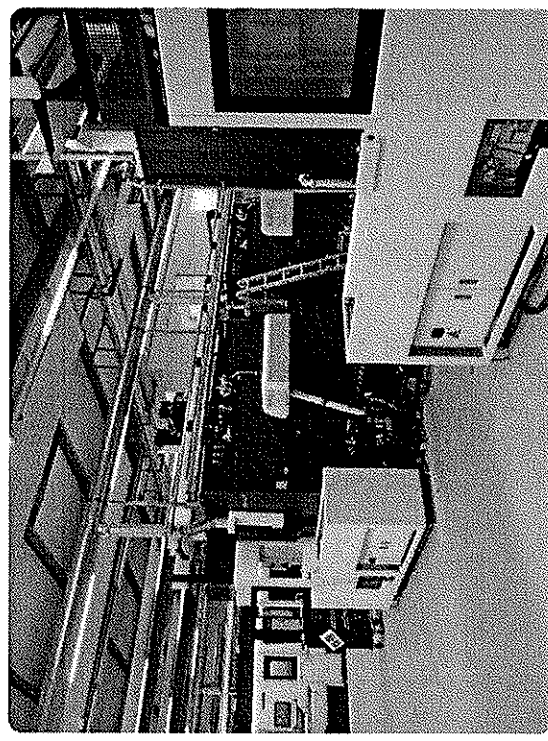

IN GERMANY

This is a fully robotized facility for machining at Erla, which incorporates the latest technological innovations and will allow Dynamatic to increase its competitiveness in manufacturing high volume precision parts for BMW.

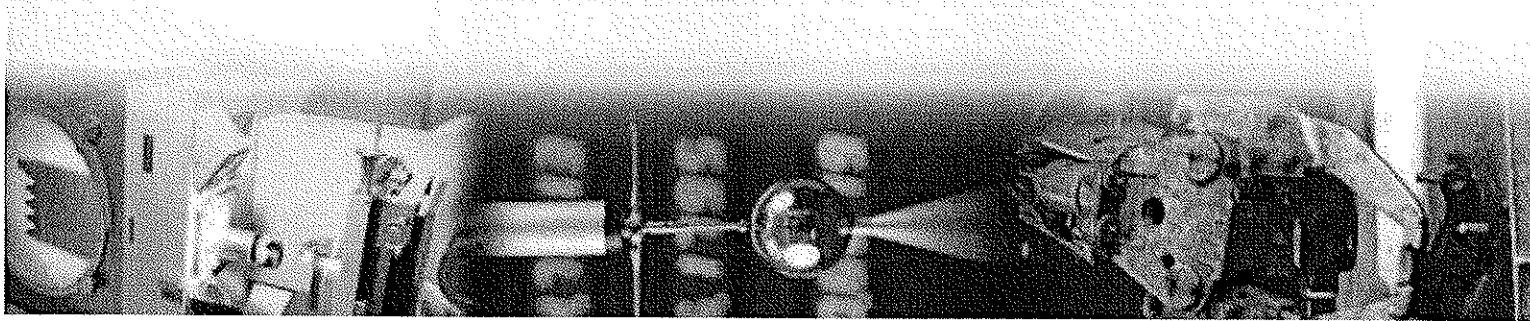

DYNAMATIC TECHNOLOGIES LIMITED



PERFORMANCE HIGHLIGHTS

Management Commentary

Commenting on the results, **Mr. Udayant Malhoutra, CEO and Managing Director** said:

“The last one year has been an exciting time for Dynamatic Technologies. We have not just registered robust financial performance during the year but have also enhanced our brand equity and reinforced our market position globally. This in particular is reflected in the success of our Aerospace & Defence business and our key focus on product innovation and advanced technology platform. It is in testament to the UK Prime Minister Ms. Theresa May, visiting our facility in Bangalore. It was followed by a milestone announcement of commercial production of Airbus A330 Long Range FTBs to be manufactured in India and UK during the life of the program.

Dynamatic Technologies is pleased to announce a robust set of financials for the 12M FY2017. The growth in EBITDA and PAT coupled with a significant margin expansion was underpinned by the strong Aerospace & Defence business platform that we have built over the years. This was closely followed by our Hydraulics segment, whose performance remained stable despite a temporary impact of demonetization in India and unfavourable foreign exchange fluctuation in the UK.

With a strategic focus on further enhancing our Aerospace business, we are proud to state that we inaugurated our new Aerospace facility in Bangalore – Dynamatic Aeropolis in February, 2017. This facility has already started order execution for Airbus A330 and Bell Helicopter. Dynamatic Technologies is stepping towards the next level of growth and we remain committed to create value for all our stakeholders”.

DYNAMATIC TECHNOLOGIES LIMITED



PERFORMANCE HIGHLIGHTS

Foreign Exchange Fluctuation

Exchange Rate	Q4 FY2017	Q4 FY2016	Impact	Impact %	Q3 FY2017	Impact	Impact %
EURO vs. INR	73.59	72.31	1.28	1.77%	74.35	(0.76)	(1.02)%
GBP vs. INR	87.66	98.76	(11.11)	(11.24)%	89.30	(1.64)	(1.84)%
USD vs. INR	67.10	65.46	1.64	2.50%	67.12	(0.02)	(0.04)%

Impact due to change in average exchange rates (Y-o-Y)

Particulars	Q4 FY2017 vs. Q4 FY2016				FY2017 vs. FY2016			
	Erla	DL UK	JFTL	Total Impact	Erla	DL UK	JFTL	Total Impact
Currency	EURO	GBP	EURO		EURO	GBP	EURO	
Revenue (Rs. mn)	33.9	(67.9)	1.4	(37.4)	134.9	(279.7)	6.9	(164.3)
EBITDA (Rs. mn)	2.1	(77.0)	1.4	(9.0)	6.6	(38.0)	6.9	(50.9)

- On a constant currency basis, FY2017 revenue, if adjusted for a foreign exchange impact of Rs. (164) mn would be Rs. 15,242 mn, representing a growth of 2.0% y-o-y compared to 0.9% growth before adjustment
- On a constant currency basis, FY2017 EBITDA, if adjusted for a foreign exchange impact of Rs. (51) mn would be Rs. 1,704 mn, representing a growth of 20.8% y-o-y (vs. 17.2%)
- The Company has exposure to EUR, GBP and USD. The impact from EUR denominated transactions had a positive impact on performance. However, GBP denominated transactions had an unfavorable impact. Impact from USD was relatively flat y-o-y

DYNAMIC TECHNOLOGIES LIMITED

AEROSPACE AND DEFENCE SEGMENT

Financial Overview

Rs. million	Q4		Y-o-Y Growth (%)	Q3 FY17	q-o-q Growth (%)	Twelve Month		Y-o-Y Growth (%)
	FY17	FY16				FY17	FY16	
Revenue	902	783	15.3%	874	3.3%	3,457	2,698	28.1%
India	653	521	25.3%	581	12.4%	2,265	1,475	53.6%
UK	250	262	(4.6)%	293	(14.8)%	1,192	1,223	(2.6)%
EBITDA	239	281	(14.8)%	273	(12.3)%	1,047	764	37.2%
Margin (%)	26.5%	35.9%		31.2%		30.3%	28.3%	
India	200	257	(22.2)%	188	6.4%	809	598	35.3%
Margin (%)	30.6%	49.3%		32.4%		35.7%	40.5%	
UK	39	24	66.3%	85	(53.7)%	238	166	43.7%
Margin (%)	15.8%	9.0%		29.0%		20.0%	13.5%	

Q4 FY17 Revenue Breakup

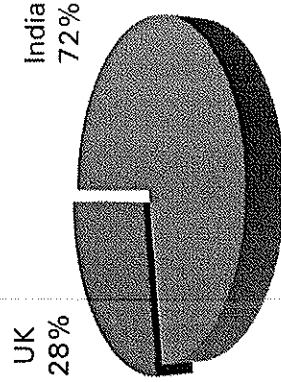

Performance Overview

- Successful deliveries of new projects along with a robust and continuing order book execution, led to substantial revenue growth for both Q4 and full year FY2017
- **Outlook:** Strong order book. New enquiries and orders to further strengthen the order book. Order execution for Airbus and Bell Helicopters begins at the new facility in Bangalore. This will lead to a significant ramp up in production, going forward.
- **Strategy:** Developing capabilities in large aero-structural assemblies, composites, and high precision aero-structure design and engineering

DYNAMATIC TECHNOLOGIES LIMITED



HYDRAULICS SEGMENT

Financial Overview

Rs. million	Q4		Y-o-y Growth (%)	Q3	Twelve Month		Y-o-y Growth (%)
	FY17	FY16			FY17	FY16	
Revenue	700	683	2.5%	696	2,769	2,614	6.0%
India	483	423	14.4%	500	1,908	1,655	15.3%
UK	217	261	(16.8)%	196	862	959	(10.1)%
EBITDA	116	110	4.8%	94	398	326	22.0%
Margin (%)	16.5%	16.1%		13.6%	14.4%	12.5%	
India	91	76	19.5%	80	335	283	18.4%
Margin (%)	18.9%	18.0%		16.0%	17.5%	17.1%	
UK	24	34	(28.1)%	15	63	43	45.6%
Margin (%)	11.3%	13.1%		7.4%	7.3%	4.5%	

Q4 FY17 Revenue Breakup

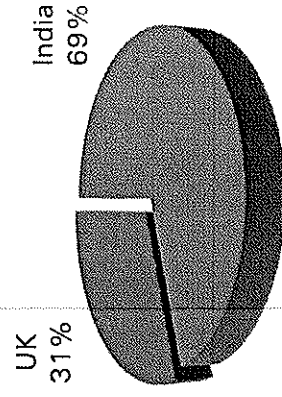

Performance Overview

- Hydraulics segment in India continued its strong performance. The sales remained robust along with a significant margin expansion. On a constant currency basis UK registered marginal growth
- With a recently established sales office in the US, the Company expects to expand further in the North American market
- Outlook:** Performance in India expected to remain strong on the back of improved farm sentiment and investment in the infrastructure sector. Started production of the new order in the UK; benefits to be realized during FY2018
- Strategy:** Focus on OEM market and exports. Growth through replacement market and lean manufacturing systems

DYNAMATIC TECHNOLOGIES LIMITED

AUTOMOTIVE SEGMENT

Financial Overview

Rs. million	Q4		Y-o-y Growth (%)	Q3		q-o-q Growth (%)	Twelve Month		Y-o-y Growth (%)
	FY17	FY16		FY17	FY16		FY17	FY16	
Revenue	2,171	2,405	(9.7)%	1,945	1,945	11.6%	8,833	9,605	(8.0)%
India – M	183	218	(15.9)%	161	161	11.9%	733	985	(25.5)%
India – F	220	289	(23.9)%	171	171	28.8%	933	1,290	(27.6)%
India – F: Inter Co. Settlement	(117)	(202)	nm	(109)	(109)	nm	(569)	(984)	nm
Germany	1,885	2,100	(10.2)%	1,719	1,719	9.7%	7,736	8,315	(7.0)%
EBITDA	88	157	(44.1)%	(8)	(8)	nm	294	393	(25.2)%
Margin (%)	4.0%	6.5%		(0.4)%	(0.4)%		3.3%	4.1%	
India – M	(33)	(20)	nm	(31)	(31)	nm	(106)	(105)	nm
Margin (%)	(18.2)%	(9.2)%		(18.9)%	(18.9)%		(14.5)%	(10.7)%	
India – F	5	16	(68.3)%	(11)	(11)	nm	26	65	(60.4)%
Margin (%)	2.3%	5.4%		(6.1)%	(6.1)%		2.8%	5.1%	
Germany	116	161	(28.0)%	34	34	(100.8)%	375	433	(13.5)%
Margin (%)	6.2%	7.7%		2.0%	2.0%		4.8%	5.2%	

Performance Overview

- With the last quarter not fully recovered from the impact of demonetization, the overall automotive business demand remained subdued resulting in a decreased topline for the Company. Pre demonetization H1 revenues were 14.6% higher than H2 revenues. Growth in Germany impacted by the global Volkswagen problem
- **Outlook:** Ramp up of new orders in India to begin starting FY2018. New machining facility commissioned in Germany to drive both revenue and profitability in the coming year
- **Strategy:** Focus on high margin product mix, exports, ramp-up of existing products, performance-critical components, customer diversification, steel castings and capacity utilization



Q4 FY17 Revenue Breakup

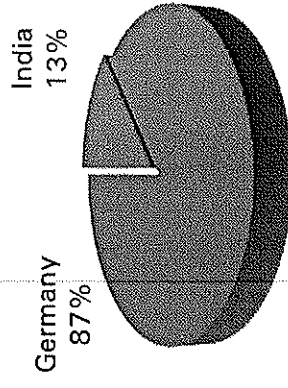

Note:

India – M: India – Machining
India – F: India – Iron Foundry

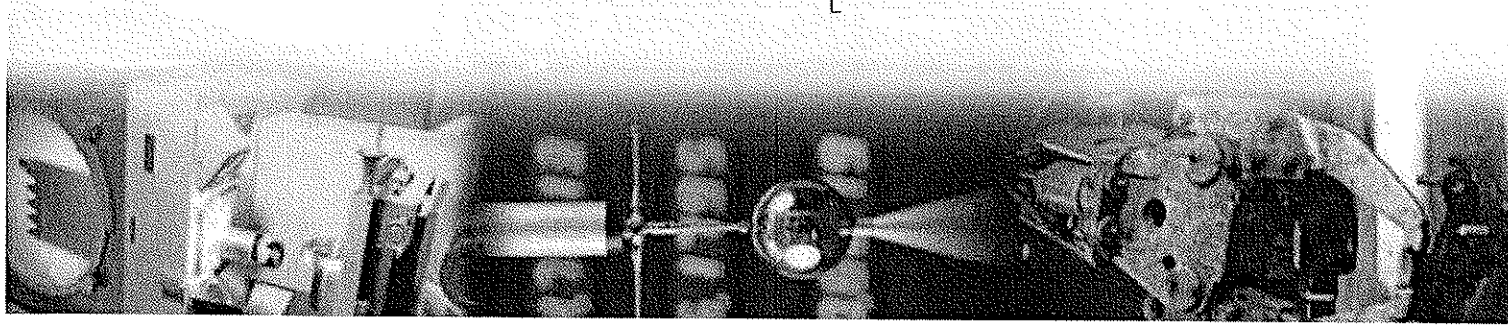

DYNAMATIC TECHNOLOGIES LIMITED

QUARTERLY FINANCIAL TRENDS

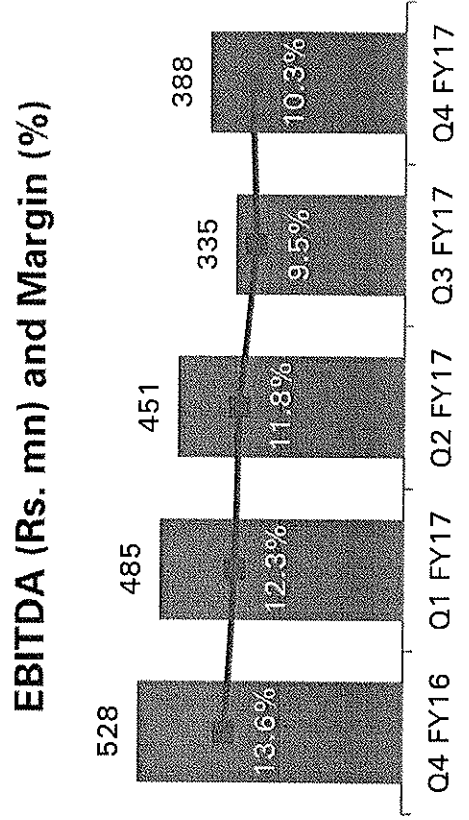
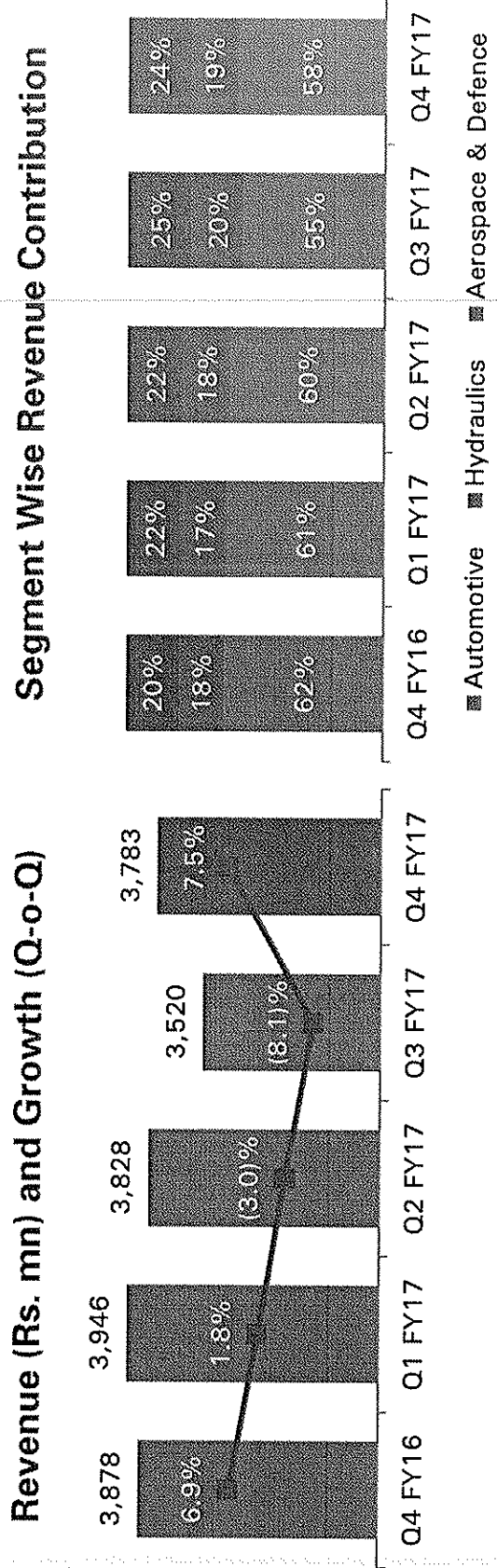

DYNAMATIC TECHNOLOGIES LIMITED



QUARTERLY FINANCIAL TRENDS

Capital Structure

(Rs. million)	Mar 31, 2017	Dec 31, 2016
Long Term Borrowings	5,092	4,936
Short Term Borrowings	1,559	1,313
Total Debt	6,651	6,249
Less: Cash & Cash Equivalents	826	318
Net Debt	5,825	5,932
Net Worth	2,464	2,592

Interest Expense (Rs. mn) & Interest Coverage (x)

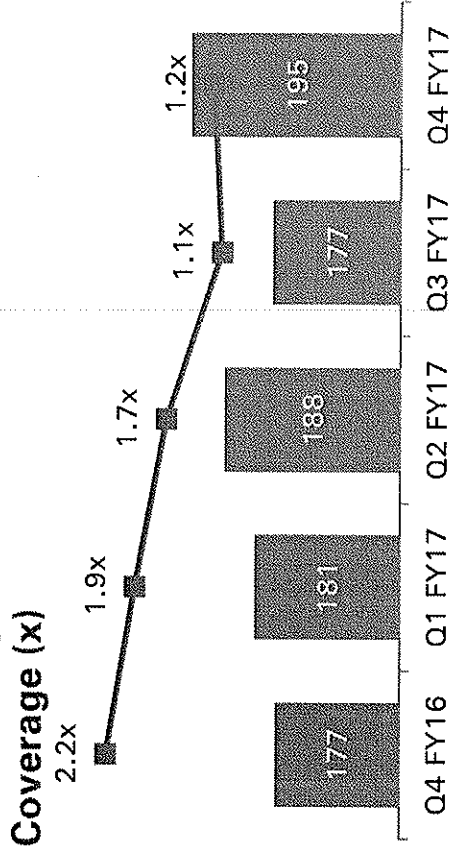

Note: Interest Coverage ratio = Operating Profit/Interest Expense

Net Debt/LTM EBITDA & Debt/Equity (x)

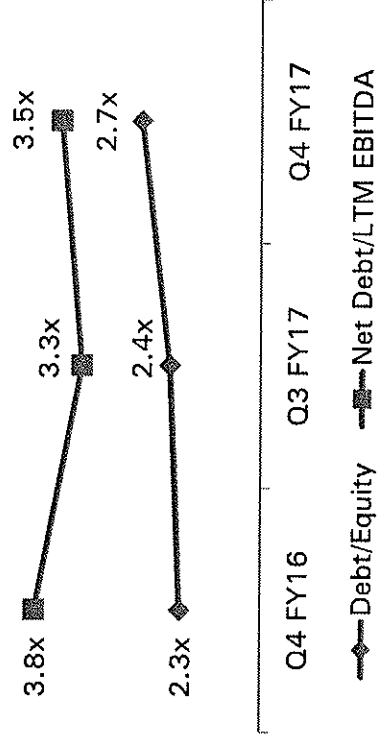

Credit Ratings

- India Rating & Research (a Fitch Group company) has assigned a long term issuer rating of "IND A-" with Stable outlook

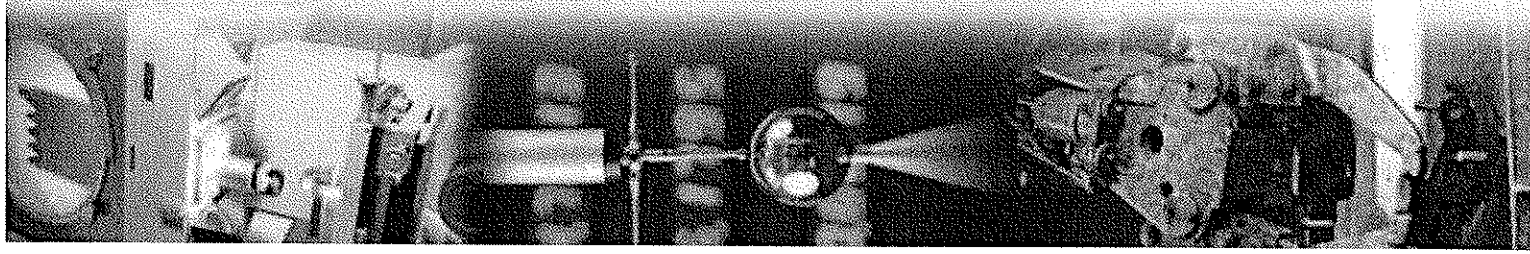

DYNAMATIC TECHNOLOGIES LIMITED



DYNAMATIC OVERVIEW

Diversified business

- A combination of stable and high growth businesses with highly engineered products for the automotive, hydraulic, aerospace and defense industries
- Successful track record of enhancing manufacturing capabilities through R&D and selective acquisitions

Competitive market position

- One of the world's largest manufacturers of hydraulic gear pumps and automotive turbochargers; leadership in hydraulic gear pumps market for over 35 years
- Has 65% share of the Indian organized tractor market, supplies to almost all OEMs in India
- Pioneer and leader in the Indian private sector for manufacture of high precision airframe structures and aerospace components. Tier 1 supplier to the global aerospace OEMs such as Airbus, Boeing, Bell Helicopters and HAL
- Manufactures high precision, complex metallurgical ferrous and aluminium castings for performance critical components such as turbochargers and exhaust manifolds and has capabilities to develop automotive components on single-source basis

Locational advantages

- Automotive facilities in Chennai, one of India's major automotive hubs and in Germany, a global auto OEM hub
- Aerospace and Defense facilities in Bangalore, headquarters of primary clients and in Bristol, UK's south west aerospace hub

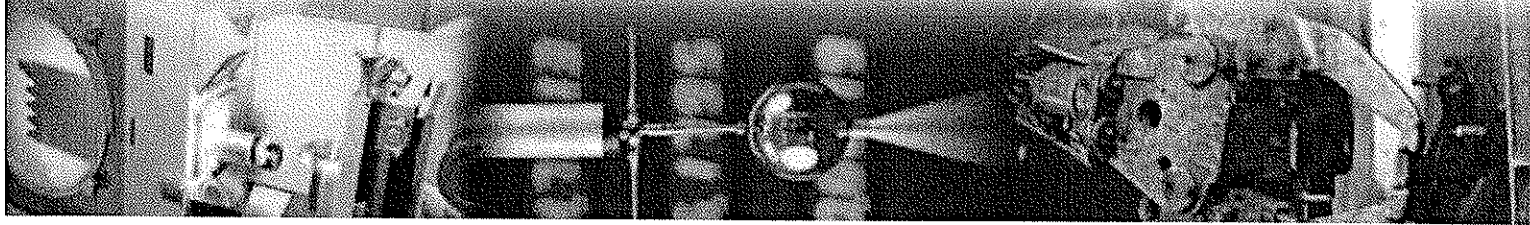

DYNAMATIC TECHNOLOGIES LIMITED



DYNAMATIC OVERVIEW

Vertically Integrated Facilities	<ul style="list-style-type: none">• Advanced iron foundry in India and Germany. Also has aluminium foundry in India for captive use• Owns one of the most advanced ferrous foundries in Europe (Germany) capable of manufacturing highly intricate castings• In-house division for design validation and optimization, analysis and prototypes• Has 11 facilities across India (Bangalore, Chennai, Coimbatore, Nasik), UK (Swindon, Bristol) and Germany (Schwarzenberg)
R&D and Intellectual Property	<ul style="list-style-type: none">• Owns 17 patents for various products in India and internationally• Has the design IP for all the products manufactured in the Hydraulics segment• R&D units recognized by Department of Scientific and Industrial Research, Government of India
Blue Chip Customers	<ul style="list-style-type: none">• Automotive: Audi, BMW, Daimler, Ford, Hyundai, Nissan, Tata Motors, Volkswagen• Hydraulics: Caterpillar, Cummins, Eicher, Escorts, John Deere, Mahindra & Mahindra, New Holland Fiat , Same Deutz-Fahr• Aerospace and Defence: Airbus, Bell Helicopter, Boeing, GKN Aerospace, HAL, Spirit Aerosystems
Board and Management	<ul style="list-style-type: none">• Highly qualified board and management team with significant industry experience• 6 out of 12 Directors Independent

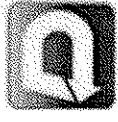

DYNAMATIC TECHNOLOGIES LIMITED

DYNAMATIC OVERVIEW

Combination of Stable and High Growth Businesses

AUTOMOTIVE

59% of Q4 FY17 Revenue



- Ferrous and non-ferrous automotive components including engine, transmission, turbocharger and chassis parts
- Metallurgical ferrous and aluminium castings

- Audi
- BMW
- Daimler
- Ford
- Hyundai
- Nissan
- Tata Motors
- Volkswagen

HYDRAULICS

18% of Q4 FY17 Revenue

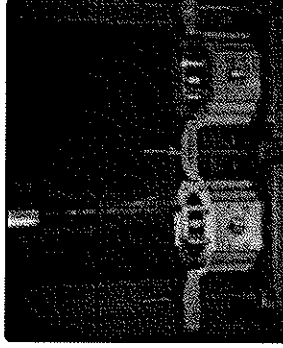

- Hydraulic valves
- Hydraulic gear pumps
- Combined displacement pump packages
- Fan drive systems
- Fixed displacement pumps

- Caterpillar
- Eicher
- Escorts
- John Deere
- Mahindra & Mahindra
- New Holland
- Fiat
- Same Deutz-Fahr

AEROSPACE & DEFENCE

23% of Q4 FY17 Revenue

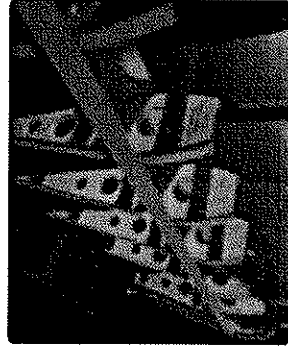

- Wings, rear fuselages, ailerons, wing flaps and major airframe structures
- Ramp structure assembly
- AFT Pylon assembly
- Defense products and solutions

- Airbus
- Boeing
- Bell
- Spirit
- HAL

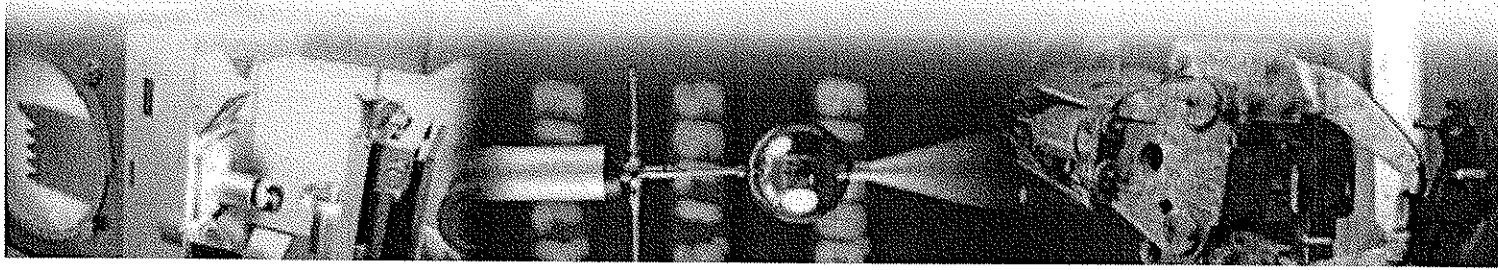



DYNAMATIC TECHNOLOGIES LIMITED

BLUE CHIP INVESTOR BASE

Shareholding Structure

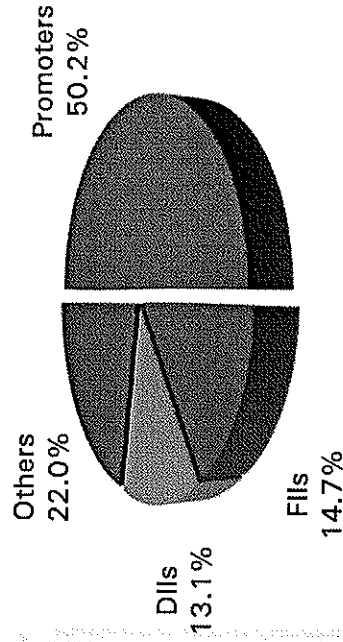

Key Institutional Investors

- Samena Capital and Citi Group
- HDFC Mutual Fund
- Alchemy and Group
- SBI Mutual Fund
- Goldman Sachs
- Mukul Agarwal and Group
- Premier Investment Fund
- Cyril Traders
- L&T Mutual Fund

Shareholding Pattern Trend

Shareholders	Sep-16	Dec-16	Mar-17
Promoters	51.1%	50.3%	50.2%
FIIs	14.5%	14.5%	14.7%
DII's	12.4%	13.1%	13.1%
Others	22.1%	22.1%	22.0%
Total	100.0%	100.0%	100.0%

Equity History

Year	Event	Equity Capital (Rs. mn)
1974	Initial Public Offering	2.9
1987	Rights Issue	11.2
1992	Rights Issue	21.0
1994	Rights Issue	31.5
1995	Bonus Issue	41.9
2008	Amalgamation	48.1
2008	Qualified Institutional Placement	54.1
2014	Preferential convertible warrants	60.4
2014	Qualified Institutional Placement	63.4



DYNAMATIC TECHNOLOGIES LIMITED

FINANCIAL STATEMENTS

Income Statement (Quarterly Trend)

	Q4FY10	Q1FY11	Q2FY11	Q3FY11	Q4FY11
Profit & Loss Statement (Rs. million)					
Revenues					
Net Sales / Income from Operations (Net of Excise Duty)	3,847	3,913	3,800	3,492	3,752
Other Operating Income	32	33	28	28	31
Total Revenues	3,878	3,946	3,828	3,520	3,783
Expenses					
Cost of Raw Materials Consumed	2,103	2,169	2,274	1,999	2,018
Changes in Inventories of Finished Goods, WIP and Stock in Trade	(14)	(26)	(163)	(2)	112
Employee Benefit Expenses	559	580	559	572	588
Other Expenditure	703	738	709	615	677
Total expenses	3,351	3,481	3,378	3,184	3,395
Operating Profit (EBITDA)	528	465	451	335	388
Depreciation and Amortization Expenses	138	128	131	133	151
EBIT	390	337	319	202	236
Other Income	28	26	10	11	11
Finance Costs	177	181	188	177	195
PBT - Pre Exceptional	241	202	142	30	83
Exceptional (Gain)/Losses	0	5	0	0	101
PBT	241	197	142	30	(18)
Tax Expenses	49	68	82	24	26
PAT	192	129	80	12	(14.6)
Basic EPS (Rs)	30.30	20.32	12.89	1.86	(11.78)
Margins (%)					
Gross Margins	46.1%	45.7%	44.9%	43.3%	43.7%
EBITDA margins	73.6%	72.3%	71.8%	9.5%	70.3%
PAT margins	6.0%	3.3%	2.1%	0.3%	(2.0)%
Y-o-Y Growth (%)					
Total Revenues	10.2%	5.9%	3.4%	(3.0)%	(2.5)%
EBITDA	59.4%	98.2%	33.3%	11.8%	(28.5)%
PAT	281.2%	nm	2453.1%	(52.1)%	nm
Q-o-Q Growth (%)					
Total Revenues	6.9%	1.8%	(3.0)%	18.1%	7.5%
EBITDA	75.6%	(8.0)%	7.1%	(25.8)%	15.6%
PAT	687.5%	(32.9)%	(37.5)%	(85.4)%	nm



DYNAMIC TECHNOLOGIES LIMITED

FINANCIAL STATEMENTS

Income Statement (Annual Trend)

	FY16	FY17
Profit & Loss Statement (Rs. million)		
Revenues		
Net Sales / Income from Operations (Net of Excise Duty)	14,806	14,957
Other Operating Income	132	120
Total Revenues	14,938	15,078
Expenses		
Cost of Raw Materials Consumed	8,502	8,459
Changes in Inventories of Finished Goods, WIP and Stock in Trade	(111)	(79)
Employee Benefit Expenses	2,192	2,300
Other Expenditure	2,945	2,744
Total expenses	13,527	13,424
Operating Profit (EBITDA)	1,410	1,653
Depreciation and Amortization Expenses	524	544
EBIT	886	1,109
Other Income	50	59
Finance Costs	727	741
PBT - Pre Exceptional	208	428
Exceptional (Gain)/ Losses	0	101
PBT	208	327
Tax Expenses	86	181
PAT	122	146
Basic EPS (Rs)	19.36	23.02
Margins (%)		
Gross Margins	45.8%	44.4%
EBITDA margins	9.4%	11.0%
PAT margins	0.8%	1.0%
Y-o-Y Growth (%)		
Total Revenues		0.9%
EBITDA		17.2%
PAT		19.0%

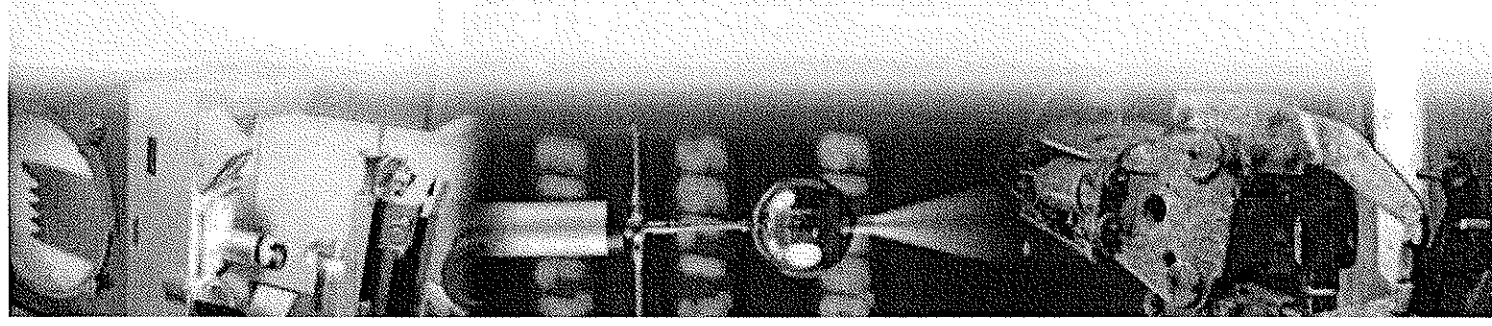



DYNAMATIC TECHNOLOGIES LIMITED

FINANCIAL STATEMENTS

Balance Sheet – Assets

Balance Sheet (Rs. million)	Mar-16	Mar-17
ASSETS		
Non-Current Assets		
Goodwill	936	826
Fixed Assets	5,617	5,896
Non-Current Investment	1	7
Deferred tax asset (net)	0	0
Long Term Loans and Advances	260	254
Other Non Current Assets	78	62
Total Non-Current Assets	6,892	7,046
Current Assets		
Inventories	2,561	2,574
Trade Receivables / Sundry Debtors	1,228	1,519
Cash and Cash Equivalents	677	826
Short-Term Loans and Advances	356	410
Other Current Assets	111	120
Total Current Assets	4,933	5,450
TOTAL ASSETS	11,825	12,495

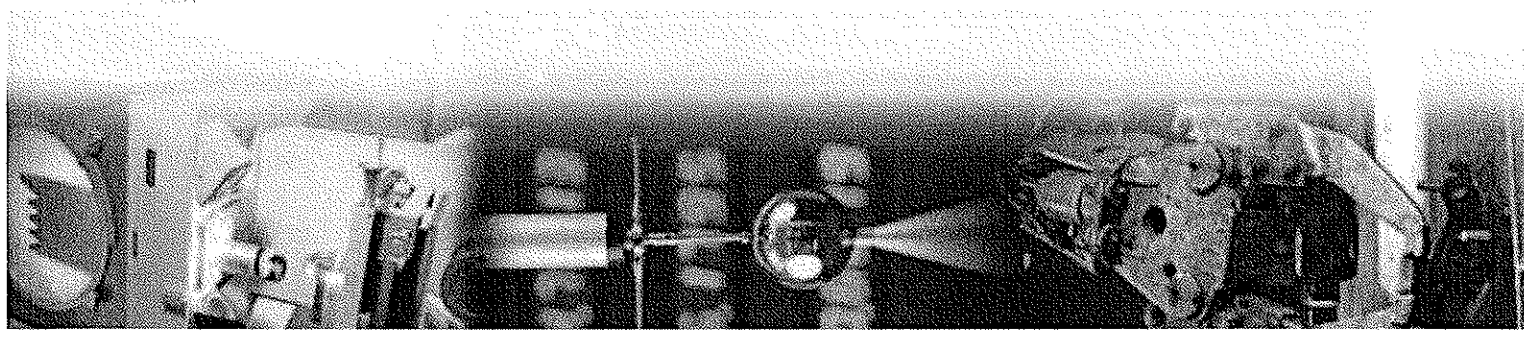



DYNAMATIC TECHNOLOGIES LIMITED

FINANCIAL STATEMENTS

Balance Sheet – Liabilities

Balance Sheet (Rs. million)	Mar-16	Mar-17
EQUITY and LIABILITIES		
Shareholders Fund		
Share capital	63	63
Reserves and surplus	2,513	2,401
Money Received against Share Warrants	0	0
Non-controlling interest (Preference capital)	0	0
Total Shareholders Fund	2,576	2,464
Non-Current Liabilities		
Long-Term Borrowings	3,999	4,686
Deferred Tax Liabilities (net)	253	232
Other Long Term Liabilities	15	12
Long Term Provisions	80	98
Total Non-Current Liabilities	4,347	5,027
Current Liabilities		
Short-Term Borrowings	920	1,559
Trade Payables	2,402	2,434
Other Current Liabilities	1,457	866
Short-Term Provisions	123	145
Total Current Liabilities	4,902	5,004
TOTAL EQUITY AND LIABILITIES	11,825	12,495

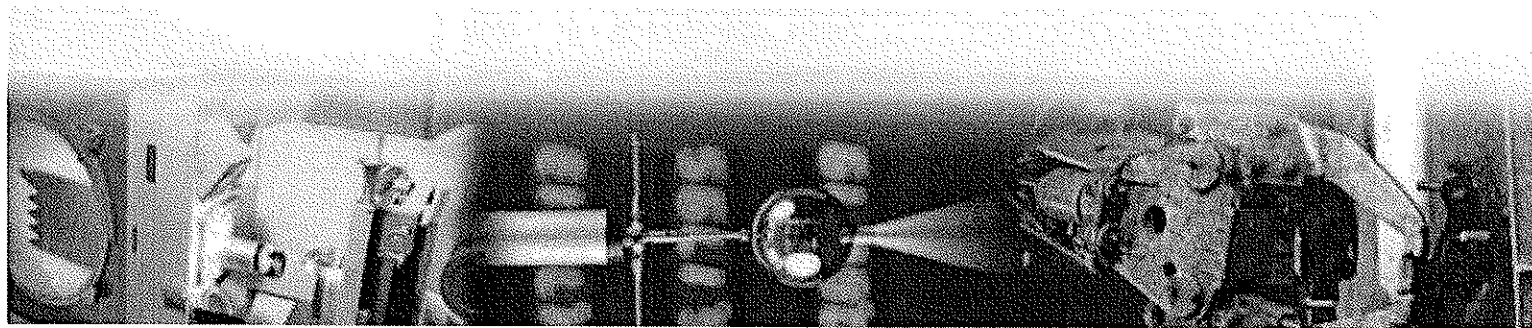

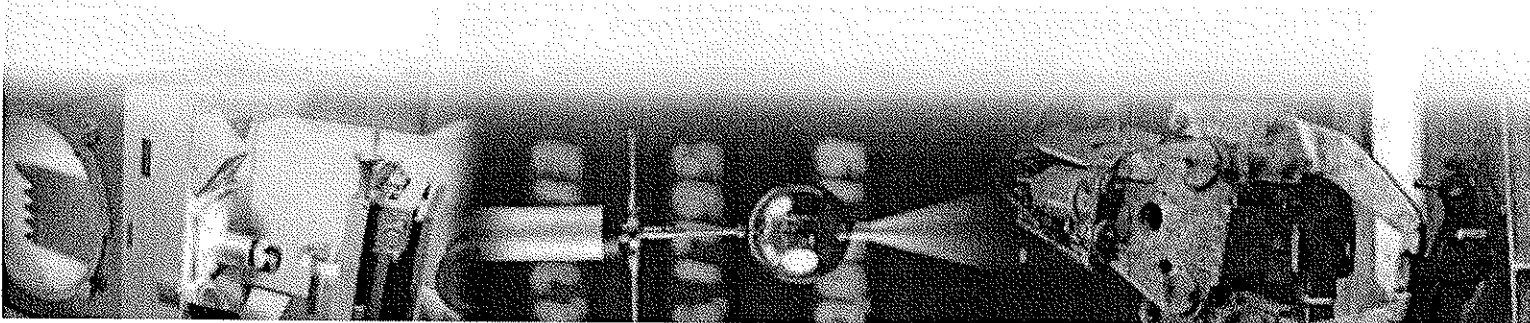

DYNAMATIC TECHNOLOGIES LIMITED



IMPORTANT NOTICE

This presentation contains statements that contain “forward looking statements” including, but without limitation, statements relating to the implementation of strategic initiatives, and other statements relating to Dynamatic Technologies’ (“Dynamatic” or the “Company”) future business developments and economic performance.

While these forward looking statements indicate our assessment and future expectations concerning the development of our business, a number of risks, uncertainties and other unknown factors could cause actual developments and results to differ materially from our expectations.

These factors include, but are not limited to, general market, macro-economic, governmental and regulatory trends, movements in currency exchange and interest rates, competitive pressures, technological developments, changes in the financial conditions of third parties dealing with us, legislative developments, and other key factors that could affect our business and financial performance.

Dynamatic Technologies undertakes no obligation to publicly revise any forward looking statements to reflect future / likely events or circumstances.

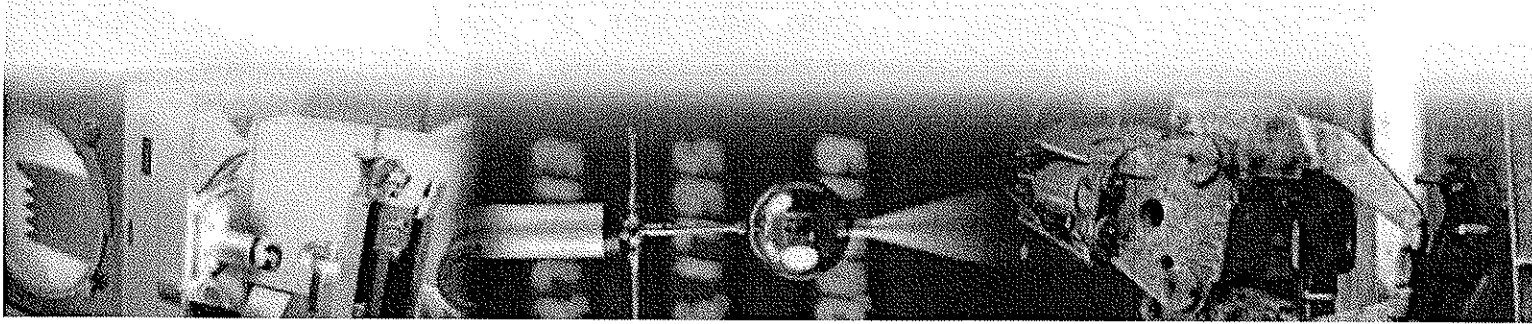

DYNAMATIC TECHNOLOGIES LIMITED

CONTACT DETAILS

Mr. Hanuman Sharma
Executive Director and Group Chief Financial Officer

Dynamatic Technologies Limited
Dynamatic Park Peenya Industrial Area
Bangalore 560 058 India
T: +91 80 2839 4933 / 34 / 35
F: +91 80 2839 5823
E: hanuman.sharma@dynamatics.net

Mr. Naveen Chandra
Head – Legal, Compliance & Company Secretary

Dynamatic Technologies Limited
Dynamatic Park Peenya Industrial Area
Bangalore 560 058 India
T: +91 80 2839 4933 / 34 / 35
F: +91 80 2839 5823
E: naveen.c@dynamatics.net

CIN: L72200KA1973PLC002308

www.dynamatics.net

